

# Bluubit

COMPANY PRESENTATION

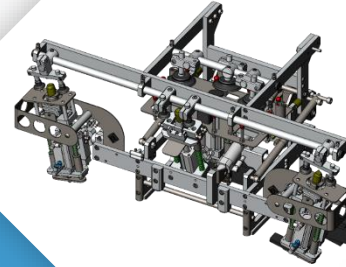

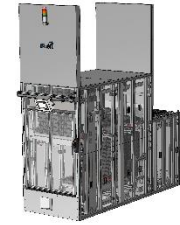

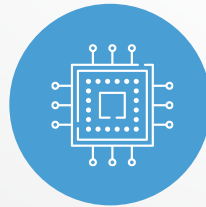

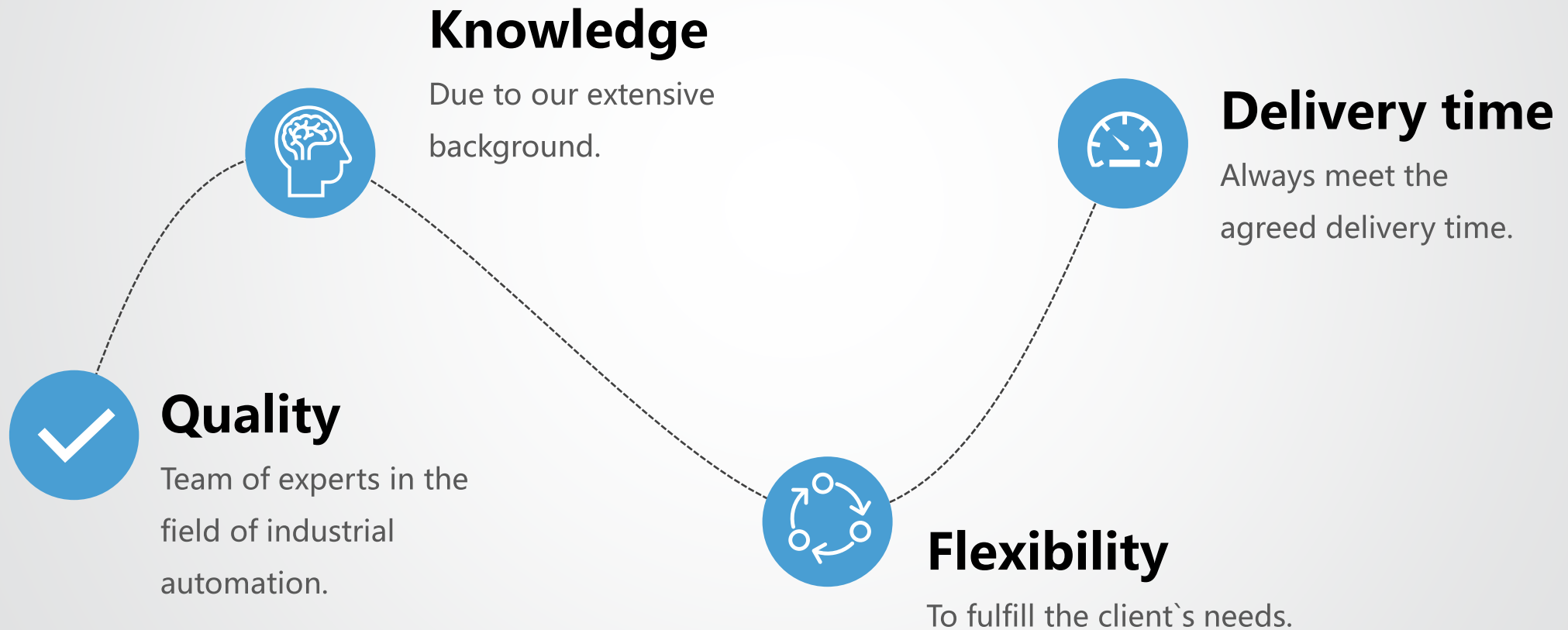

# WHAT DRIVES US?





# WHY BLUBIT?



-  We **raise** the quality of your products
-  We **increase** your production capacities
-  We **decrease** your production costs
-  We **improve** your market position



# WHAT WE DO?

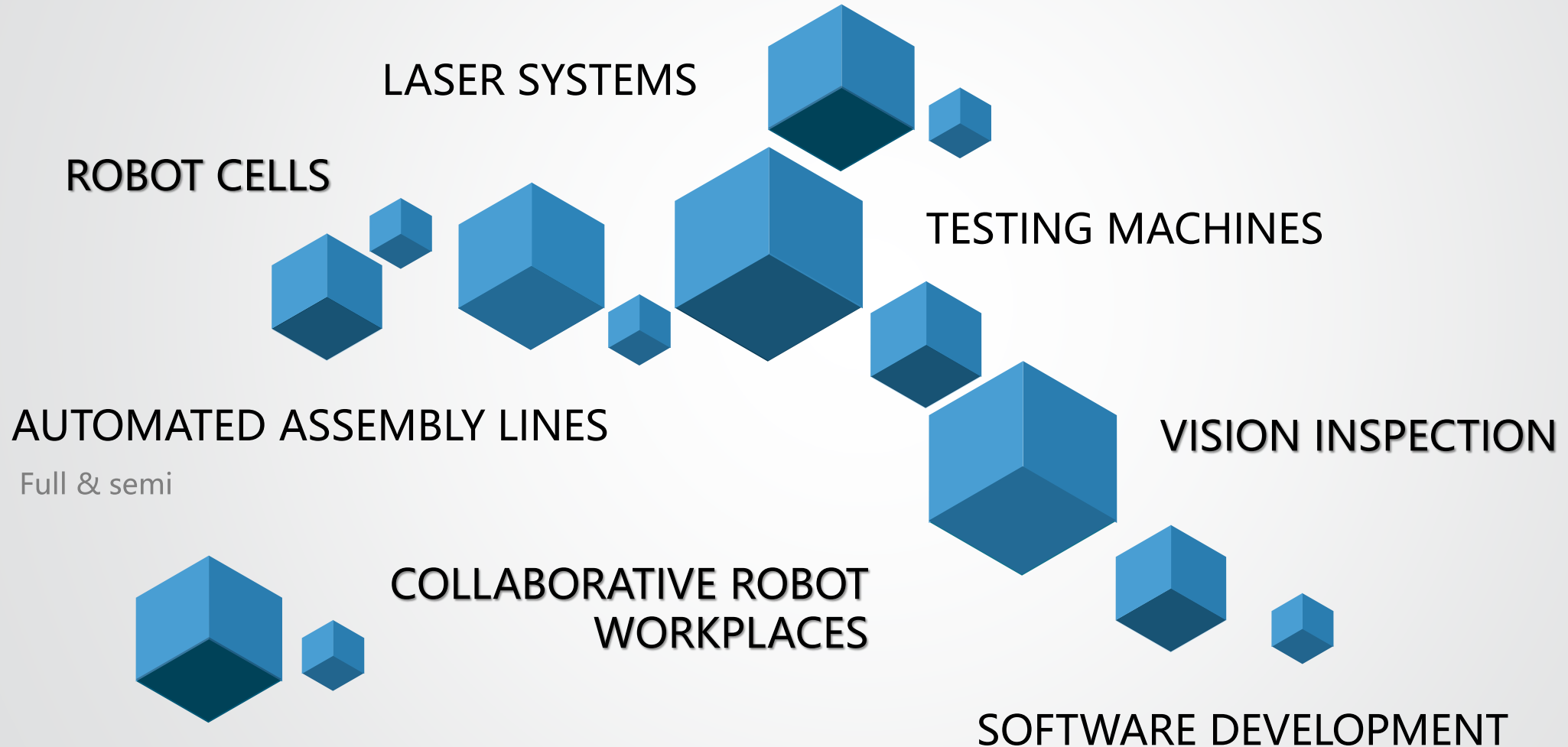



# IN-HOUSE CAPABILITIES

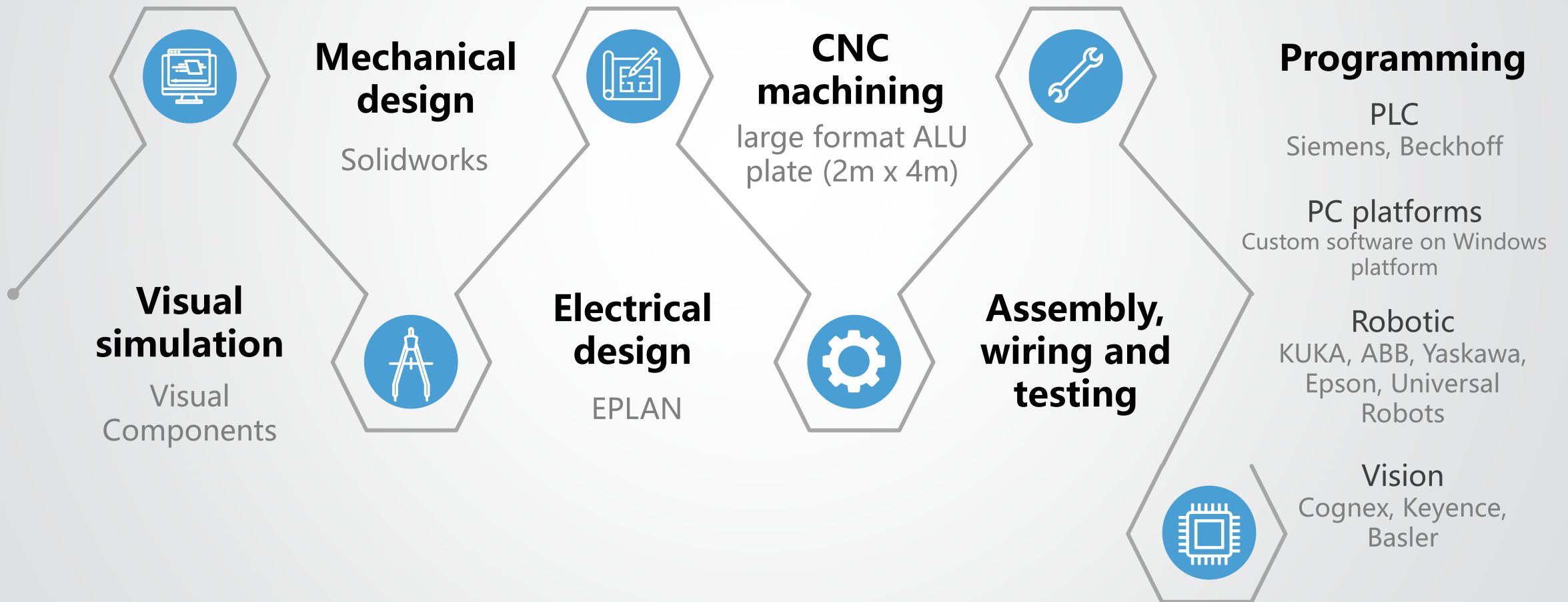



# INDUSTRIES

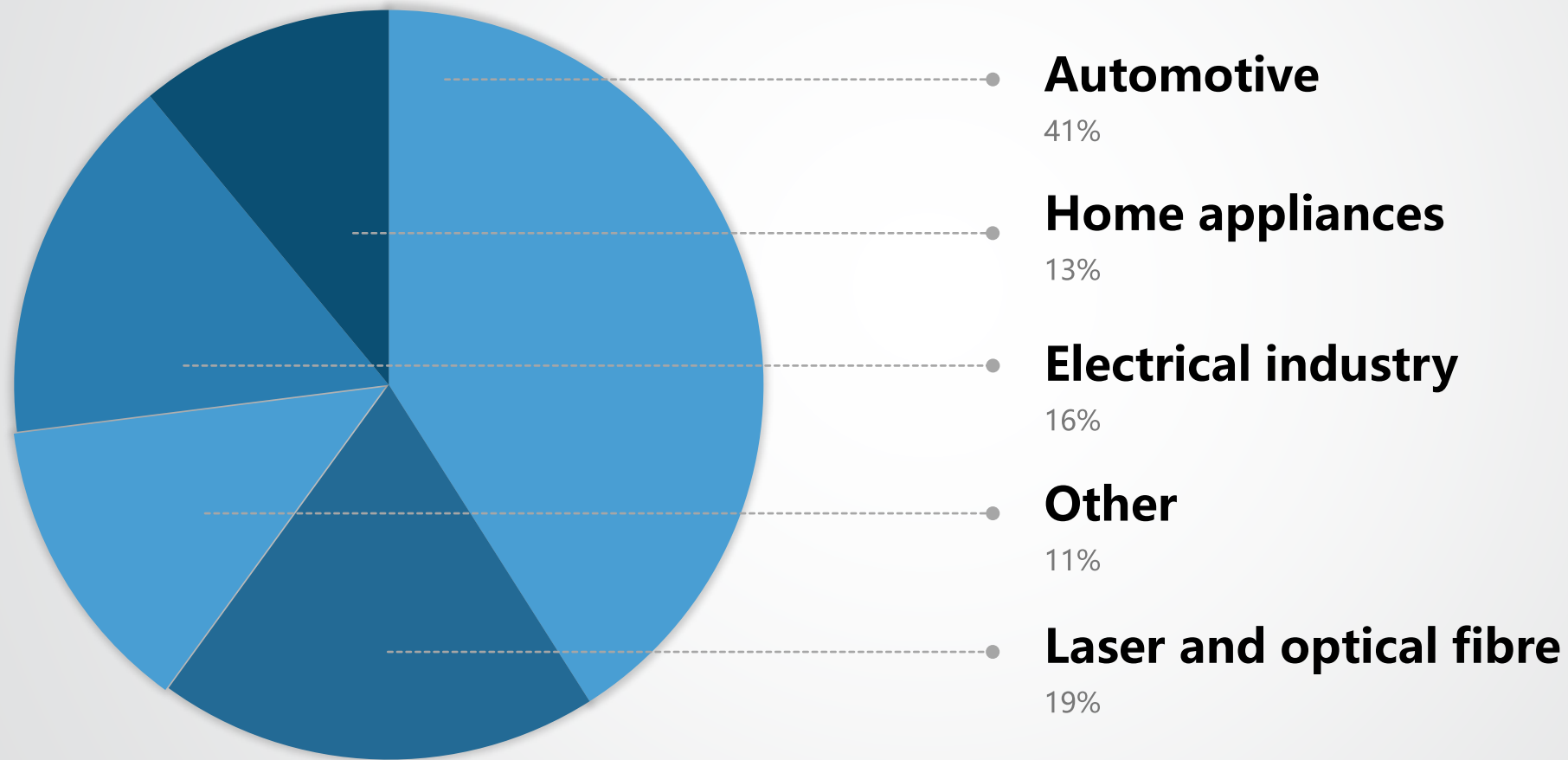

# QUICK FACTS

## Turnover

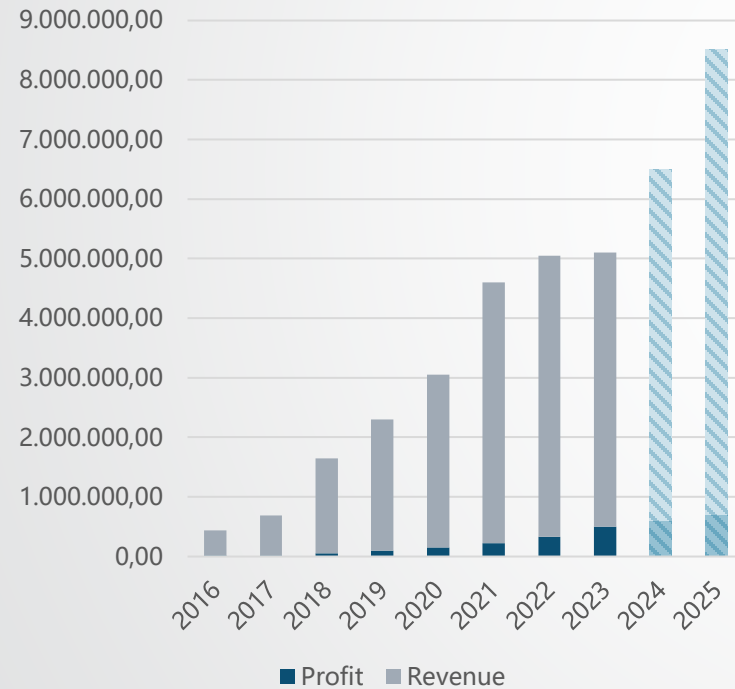

## Employees

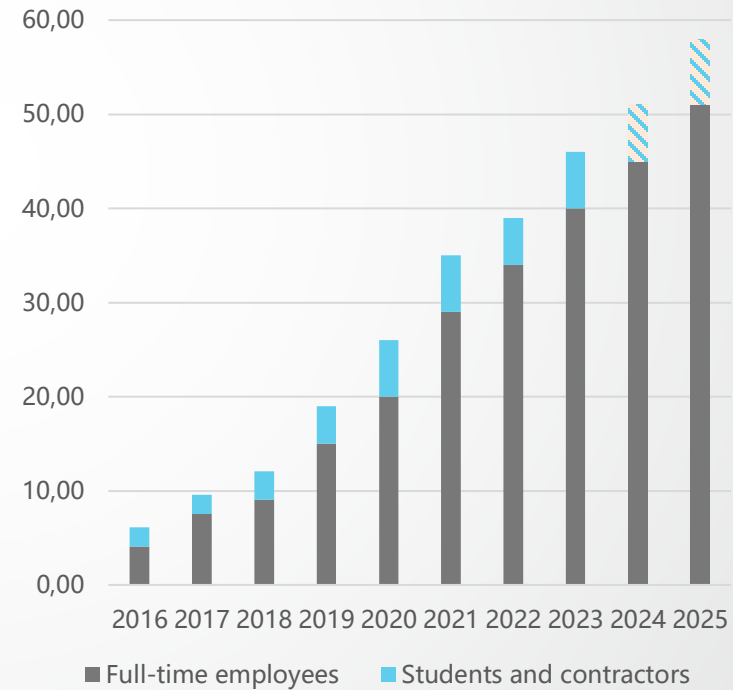



# SIMULATIONS

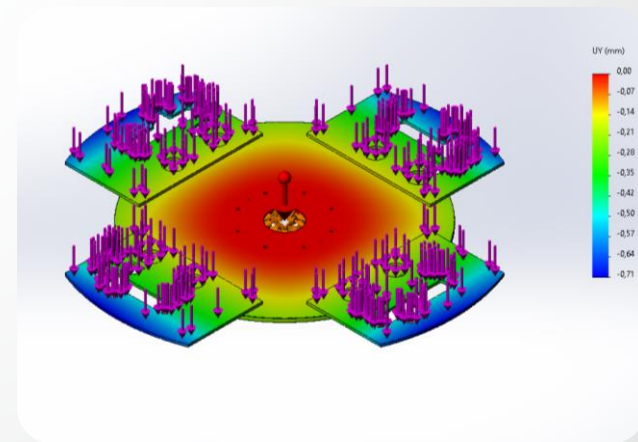
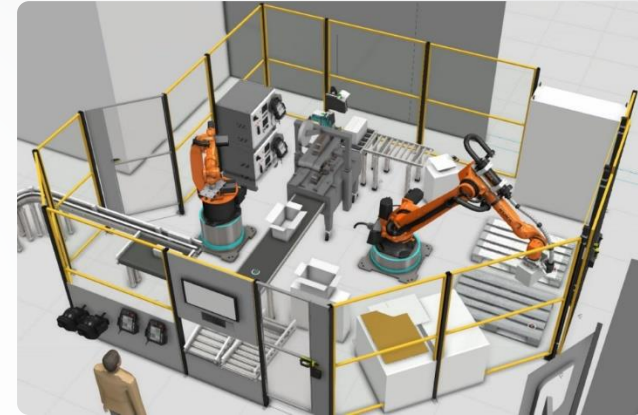
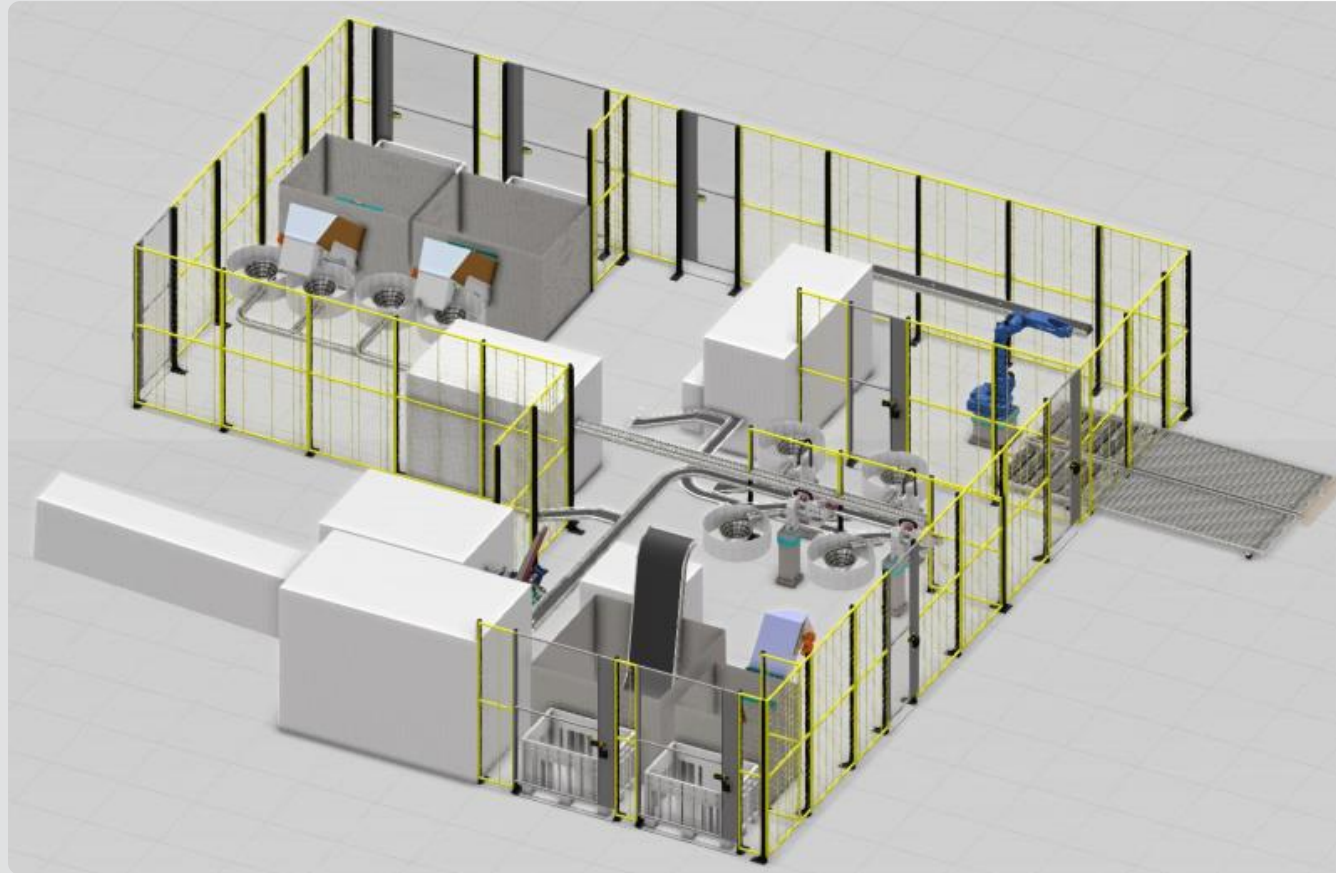



# ROBOTIC CELLS

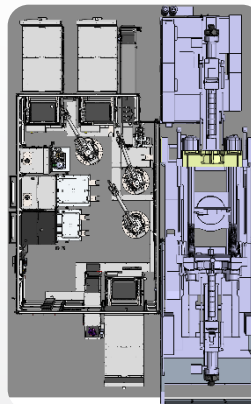
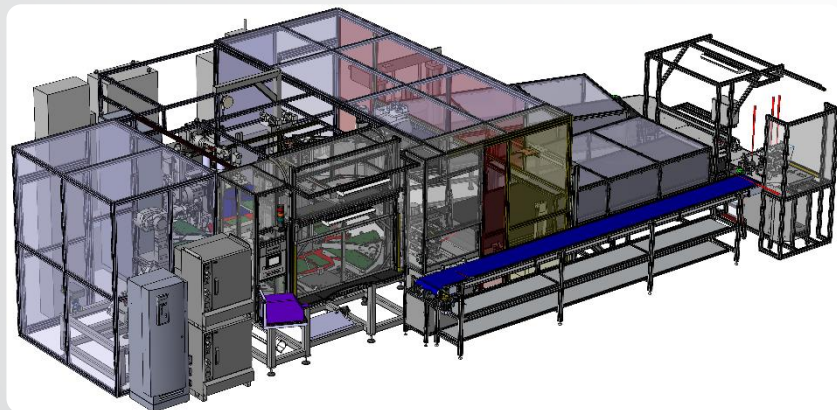
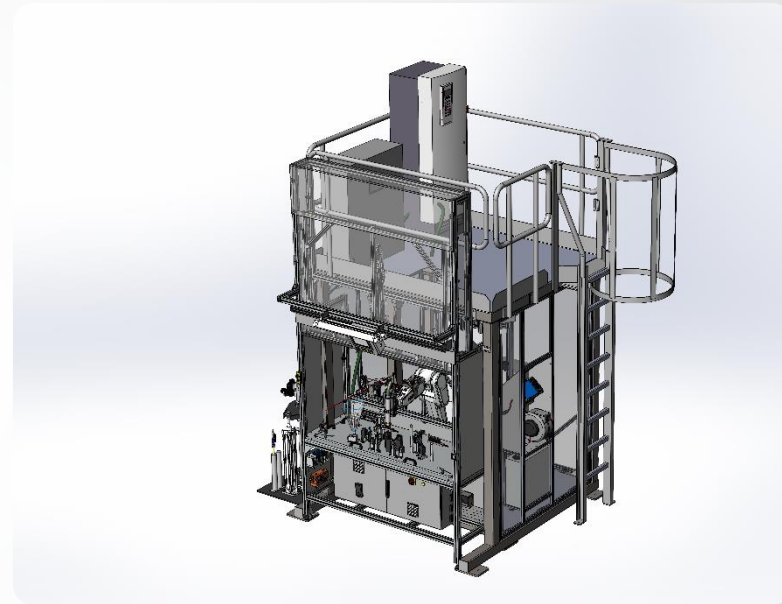
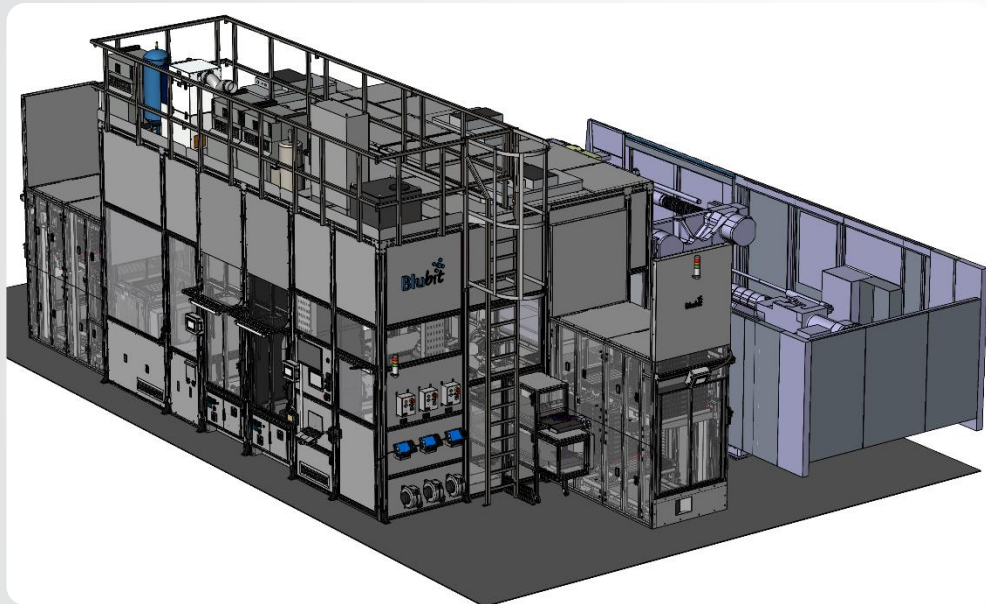



# ASSEMBLY LINES

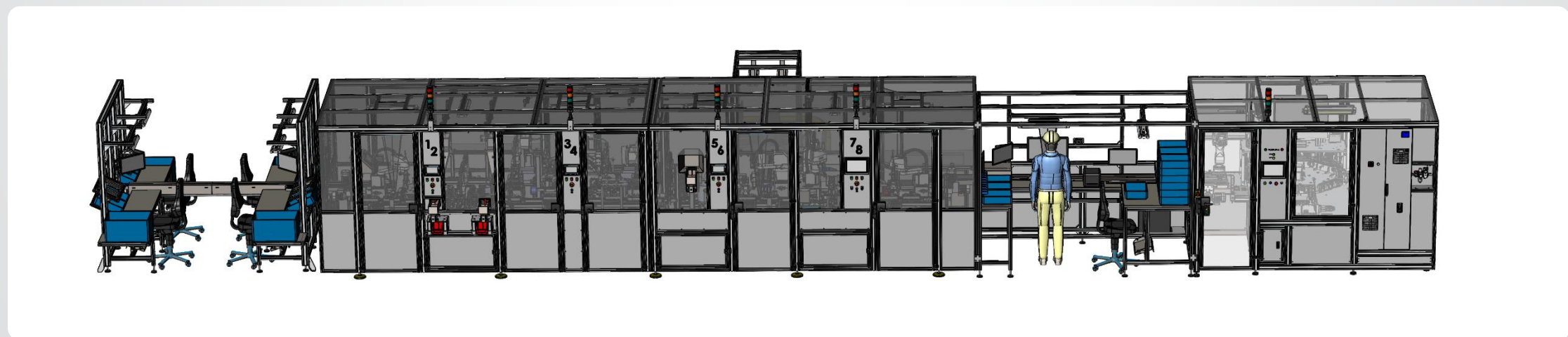
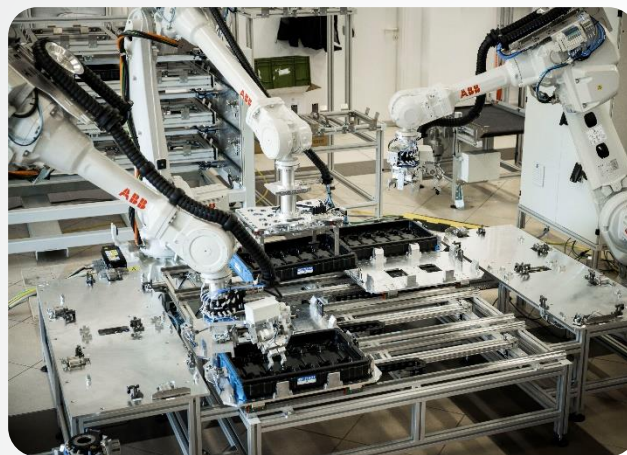
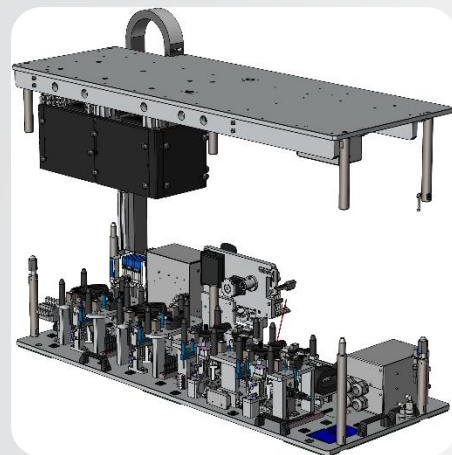



# VISION SYSTEMS

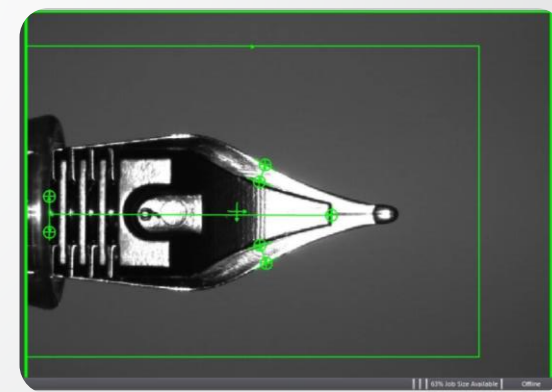
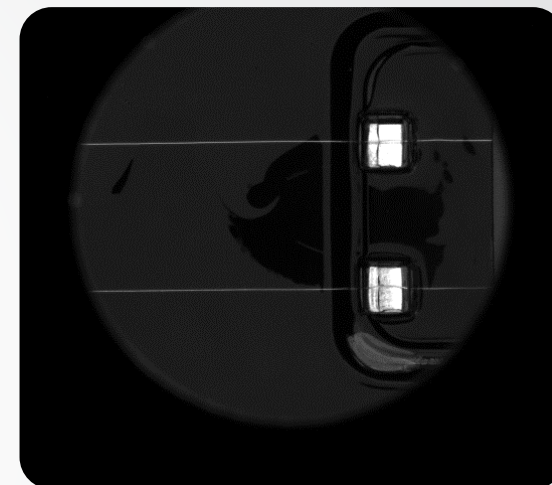
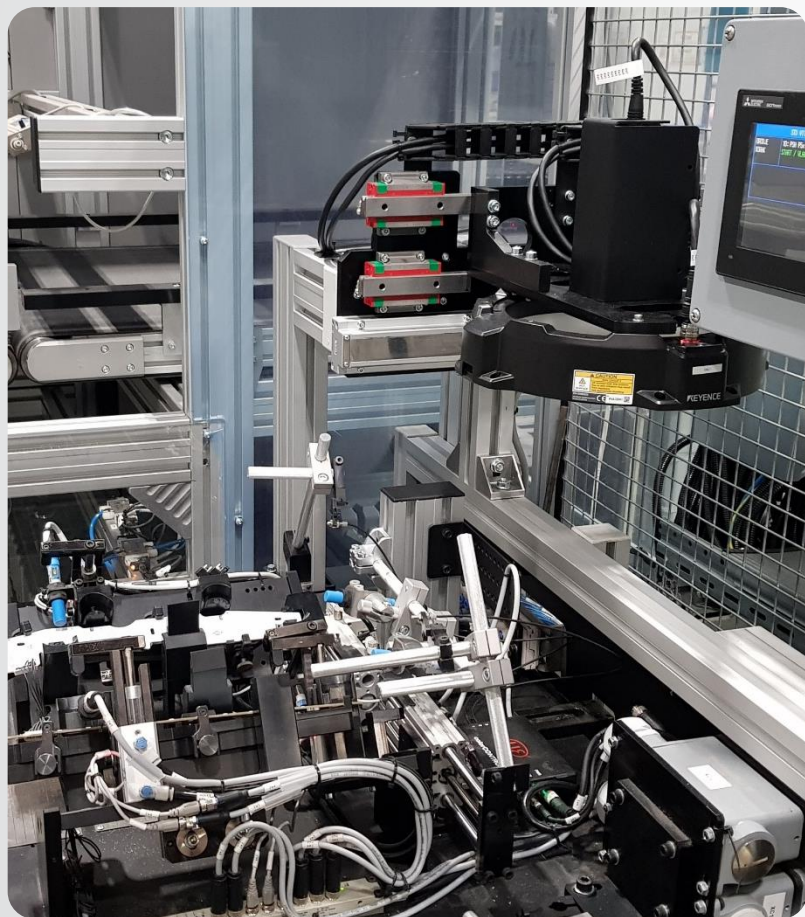



# TESTING MACHINES

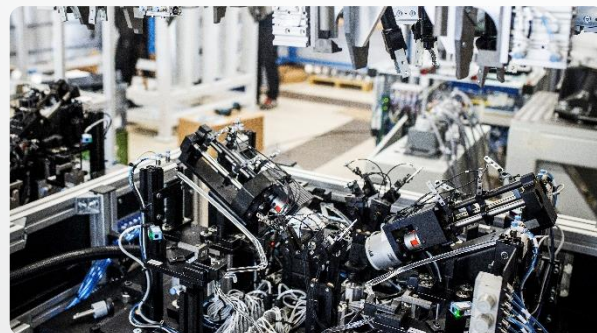
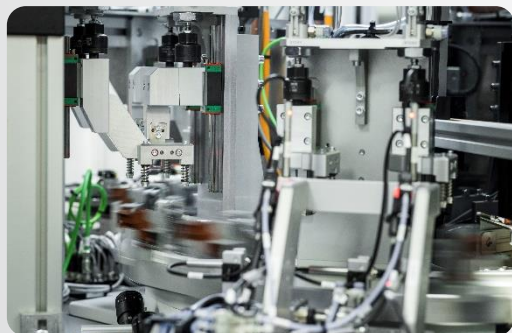
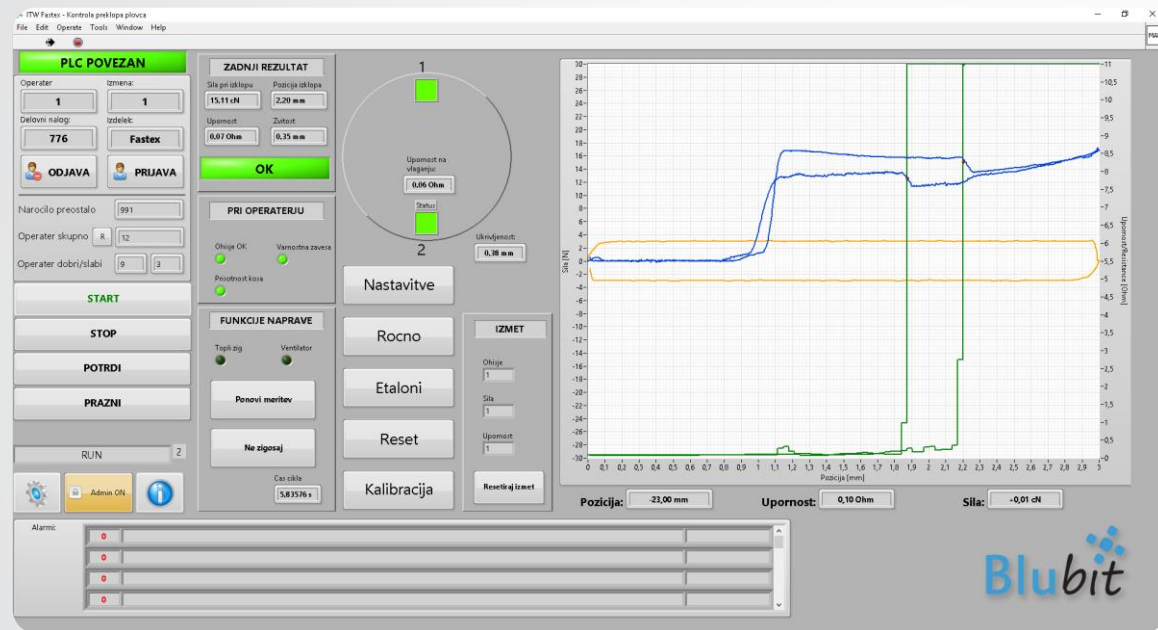



# FACILITIES

## ASSEMBLY



2000 m<sup>2</sup> of assembly and  
warehouse space

## HEADQUARTERS



600 m<sup>2</sup> of office space

## MACHINING SITE



Large format CNC



# OUR PARTNERS





**Sales:**

Jan Jakus

[jan.jakus@blubit.si](mailto:jan.jakus@blubit.si)

+386 64 296 997

**General inquiries:**

[info@blubit.si](mailto:info@blubit.si)

+386 1 60 10 165

